



5

SAFETY STEPS TO FOLLOW IF SOMEONE IS THE VICTIM OF ELECTRICAL SHOCK

1

DO NOT TRY TO PULL OR GRAB THE INDIVIDUAL

2

IF POSSIBLE , TURN OFF THE ELECTRICAL POWER

3

IF YOU CANNOT TURN OFF THE ELECTRICAL POWER, PULL, PUSH, OR LIFT THE PERSON TO SAFETY USING A WOODEN POLE OR A ROPE OR SOME OTHER INSULATING MATERIAL

4

SEND FOR HELP AS SOON AS POSSIBLE

5

AFTER THE INJURED PERSON IS FREE OF CONTACT WITH THE SOURCE OF ELECTRICAL SHOCK, MOVE THE PERSON A SHORT DISTANCE AWAY AND IMMEDIATELY START ARTIFICIAL RESUSCITATION

**OPERATOR'S MANUAL
AM/FM MODULATION METER ME-525A/USM
(NSN 6625-01-136-8477)**

REPORTING ERRORS AND RECOMMENDING IMPROVEMENTS
 You can help improve this manual. If you find any mistakes or if you know of a way to improve the procedures, please let us know. Mail your letter, DA Form 2028 (Recommended Changes to Publications and Blank Forms), or DA Form 2028-2 located in the back of this manual direct to: Commander, US Army Communications-Electronics Command and Fort Monmouth, ATTN: DRSEL-ME-MP, Fort Monmouth, New Jersey 07703. A reply will be furnished direct to you.

		Page
	HOW TO USE THIS MANUAL	iii
CHAPTER	1. INTRODUCTION	
Section	I. General Information	1-1
	II. Equipment Description.....	1-2
	III. Technical Principles of Operation	1-7
CHAPTER	2. OPERATING INSTRUCTIONS I	
Section	I. Controls and Indicators	2-1
	II. Preventive Maintenance Checks and Services I	2-5
	III. Operation Under Usual Conditions.....	2-7
	IV. Operation Under Unusual Conditions	2-19
CHAPTER	3. MAINTENANCE INSTRUCTIONS	
Section	I. General Operator Maintenance I.....	3-0
	II. Troubleshooting Procedures	3-1
APPENDIX	A. REFERENCES	A-1
	B. COMPONENTS OF END ITEM AND BASIC ISSUE ITEMS LISTS	B-1
Section	I. Introduction	B-1
	II. Components of End Item	B-2
	III. Basic Issue Items (Not applicable)	
APPENDIX	C. ADDITIONAL AUTHORIZATION LIST ITEMS (Not applicable)	
	D. EXPENDABLE SUPPLIES AND MATERIALS LIST (Not applicable)	

HOW TO USE THIS MANUAL

This manual has been prepared in a sequentially numbered order of chapters and sections.

Each chapter contains sections given in Roman numeral order such as Section I, II, and III.

A table of contents is given at the beginning of each chapter for ready access to pages.

A bullet (•) indicates additional information needed for the paragraph above it.

A locator is provided on the right-hand border of the front cover. This gives the location in the manual of the information most frequently needed.

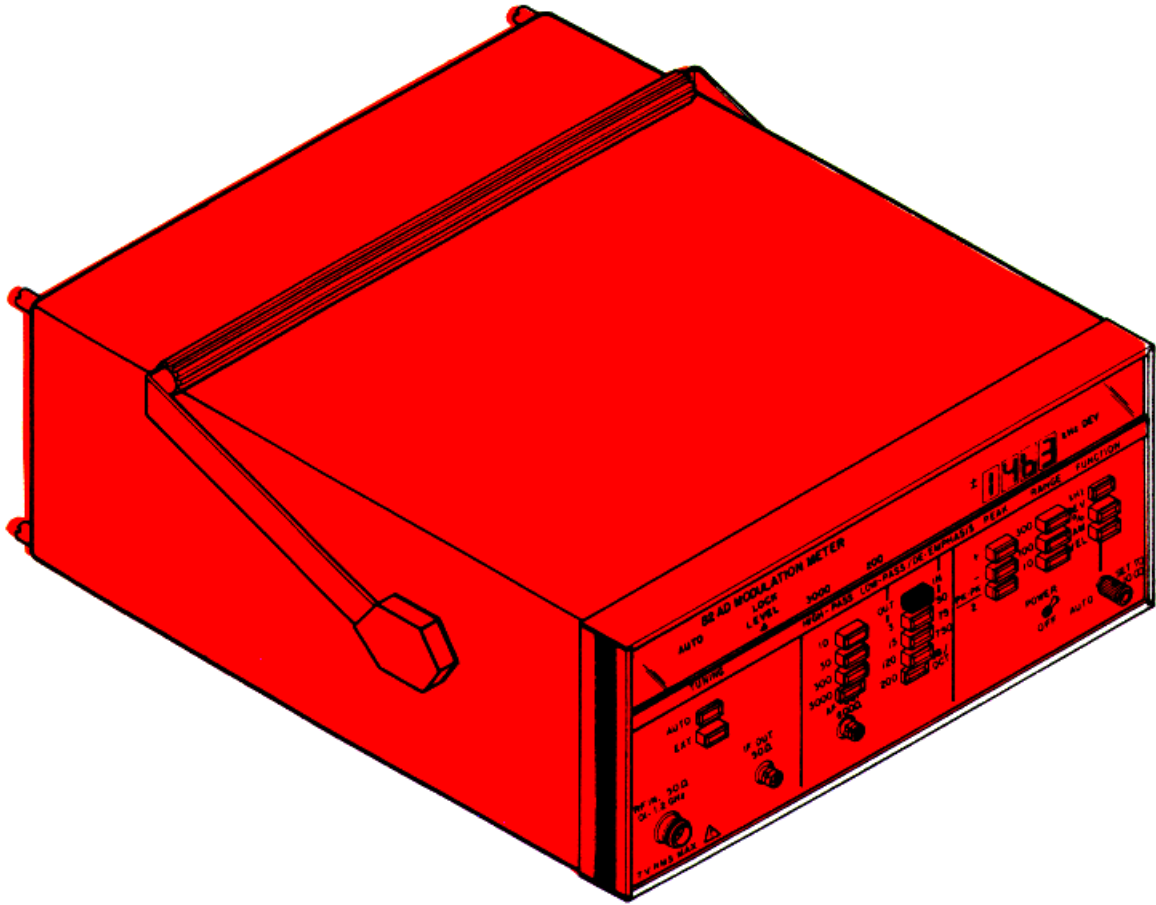

AM/FM Modulation Meter ME-525A/USM

**CHAPTER 1
INTRODUCTION**

			<i>Page</i>
Section	I.	General Information	1-1
Section	II.	Equipment Description	1-2
Section	III.	Technical Principles of Operation	1-7

Section I. General Information

SCOPE

- This manual covers operation and operator's maintenance of AM/FM Modulation Meter ME-525A/USM.
- The ME-525A/USM is used to measure amplitude modulation (AM) and frequency modulation (FM) signal characteristics of equipment used for AM and FM communications.

CONSOLIDATED INDEX OF ARMY PUBLICATIONS AND BLANK FORMS

Refer to the latest of DA Pam 310-1 to determine whether there are new editions, changes or additional publications pertaining to the equipment.

MAINTENANCE FORMS, RECORDS, AND REPORTS

Department of the Army forms and procedures used for equipment maintenance will be those prescribed by TM 38-750, The Army Maintenance Management System (TAMMS).

a. Reports of Maintenance and Unsatisfactory Equipment. Department of the Army forms and procedures used for equipment maintenance will be those prescribed by DA Pam 738-750, The Army Maintenance Management Systems (TAMMS).

b. Report of Packaging and Handling Deficiencies. Fill out and forward SF 364 (Report of Discrepancy (ROD)) as prescribed in AR 735-11-2/DLAR 4140.55/NAVMATINST 4355.73A/AFR 400-54/MCO 4430.3F.

c. Discrepancy in Shipment Report (DISREP)(SF 361). Fill out and forward Discrepancy in Shipment Report (DISREP) (SF 361) as prescribed in AR 55-38/NAVSUPINST 4610.33C/AFR 75-18/MCO P4610.19D/DLAR 4500.15.

REPORTING EQUIPMENT IMPROVEMENT RECOMMENDATIONS (EIR)

If your equipment needs improvement, let us know. Send us an EIR. You, the user are the only one who can tell us what you don't like about your equipment. Let us know why you don't like the design. Put it on SA 368 (Quality Deficiency Report). Mail it to Commander, US Army Communications-Electronics Command and Fort Monmouth, ATTN: DRSEL-ME-MP, Fort Monmouth, NJ 07703. We'll send you a reply.

DESTRUCTION OF ARMY ELECTRONICS MATERIEL

Destruction of Army electronics materiel to prevent enemy use shall be in accordance with TM 750-244-2.

Section II. Equipment Description

DESCRIPTION

FM/AM Modulation Meter M E-525AIUSM provides automatic (**AUTO**) tuning, leveling, and modulation display of AM and FM signals. Manual tuning and leveling is also possible using an external (EXT) signal using front panel controls and controls of the external signal source.

- **Automatic and Manual Operation.** The highest amplitude radio frequency(rf) carrier in the frequency range of 10 megahertz (MHz) to 1.2 gigahertz (GHz) is automatically tuned (or manually acquired by adjustment of equipment used for external input) and normalized in level to produce a 1.0 MHz intermediate frequency (if.) signal identical to the input rf carrier (AM or FM modulated). The modulating signal is detected, filtered, measured and then displayed on the digital display in percent of AM modulation or kilohertz of FM deviation.
- **Detectors.** Pushbutton switches select displays of positive or negative peak modulation or peak average, each in three ranges for FM and AM.
- **Audio Filters.** Four high and four low pass filters and four de-emphasis networks provide the means for bandpass simulation of most communications systems. The 6 decibel per octave (6 dB/OCT) pushbutton de-emphasis switch relates phase deviation to the frequency deviation displayed.

EQUIPMENT DATA

- **Weight and Dimensions**

Weight	14 lbs. (63.5 kg)
Length	15.72 in. (399.3 mm)
Width	13.68 in. (347.5 mm)
Height	6.36 in. (111.5 mm)
- **Data Plate**

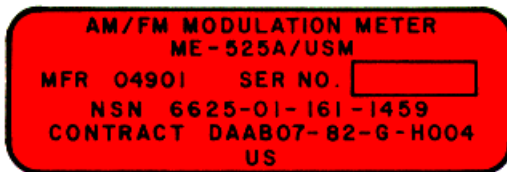

PERFORMANCE SPECIFICATIONS

<i>Parameter</i>	<i>Specifications</i>
RF INPUT:	
Carrier Frequency Range	10 MHz to 1.2 GHz
Tuning	Automatic; typical acquisition time is 100 milliseconds at 100 MHz.
Sensitivity	10 mV rms, 10 MHz to 520 MHz 30 mV rms, 520 MHz to 1.2 GHz
Level Set	Manual or automatic for levels up to 1 V rms; 2-second typical automatic acquisition time.
Maximum Safe Input	7 V rms
Input Impedance	50 ohms nominal
FREQUENCY MODULATION:	
Deviation Ranges	10, 100, and 300 kHz full-scale
Deviation Accuracy	2% of reading for deviations up to 300 kHz and modulation frequencies between 30 Hz and 100 kHz.
Modulation Frequency Range	30 Hz to 100 kHz
	NOTE Peak residuals must be subtracted to obtain full accuracy.
Residual FM	Less than 24 Hz rms at 1.2 GHz decreasing linearly with frequency to a floor of less than 3 Hz rms, 30 Hz to 3 kHz bandwidth. Less than 60 Hz rms at 1.2 GHz decreasing linearly with frequency to a floor of less than 7.5 Hz rms, 30 Hz to 15 kHz bandwidth.
AM Rejection	Less than 100 Hz deviation at 50% AM (F mod 1 kHz or less), 30 Hz to 3 kHz bandwidth.
AMPLITUDE MODULATION:	
Modulation Depth Ranges	10%, 100% fs (300% range provides reduced resolution)
Depth Accuracy	2% of reading, 10% to 90% AM 5% of reading below 10% and above 90% AM
Modulation Frequency Range	30 Hz to 100 kHz
	NOTE Peak residual AM must be subtracted for above accuracy.

PERFORMANCE SPECIFICATIONS

<i>Parameter</i>	<i>Specifications</i>															
Residual Amplitude Modulation (AM)	<p>Less than 0.05% AM rms for input levels above 100 mV rms.</p> <p>Less than 0.15% AM rms for input levels from 30 mV to 100 mV rms.</p> <p>Less than 0.45% AM rms for input levels from 10 mV to 30 mV rms.</p> <p style="text-align: center;">NOTE</p> <p>Frequency less than 500 MHz, measurement bandwidth 30 Hz to 15 kHz. Above 500 MHz, residuals increase linearly with frequency.</p>															
Frequency Modulation (FM) Rejection	Less than 0.5% AM at ± 50 kHz deviation (modulating frequency less than 100 kHz).															
Depth Accuracy	$\pm 0.7\%$ of reading at 20%, 30%, and 40% AM; f_{mod} 30 Hz to 3 kHz; filter, 10 Hz to 15 kHz.															
Detector Flatness	Indicated AM within 0.4% for constant % AM between 20% and 40% and f_{mod} of 90 to 150 Hz.															
Audio Frequency Response: Filters	<table style="margin-left: auto; margin-right: auto;"> <thead> <tr> <th style="text-align: center;"><u>High Pass</u></th> <th style="text-align: center;"><u>Low Pass</u></th> <th style="text-align: center;"><u>De-emphasis</u></th> </tr> </thead> <tbody> <tr> <td style="text-align: center;">10 Hz</td> <td style="text-align: center;">3 kHz</td> <td style="text-align: center;">50 us</td> </tr> <tr> <td style="text-align: center;">30 Hz</td> <td style="text-align: center;">15 kHz</td> <td style="text-align: center;">75 us</td> </tr> <tr> <td style="text-align: center;">300 Hz</td> <td style="text-align: center;">120 kHz</td> <td style="text-align: center;">750 us</td> </tr> <tr> <td style="text-align: center;">3000 Hz</td> <td style="text-align: center;">200 kHz</td> <td style="text-align: center;">6 dB/OCT (ref. 1 kHz)</td> </tr> </tbody> </table>	<u>High Pass</u>	<u>Low Pass</u>	<u>De-emphasis</u>	10 Hz	3 kHz	50 us	30 Hz	15 kHz	75 us	300 Hz	120 kHz	750 us	3000 Hz	200 kHz	6 dB/OCT (ref. 1 kHz)
<u>High Pass</u>	<u>Low Pass</u>	<u>De-emphasis</u>														
10 Hz	3 kHz	50 us														
30 Hz	15 kHz	75 us														
300 Hz	120 kHz	750 us														
3000 Hz	200 kHz	6 dB/OCT (ref. 1 kHz)														
Shape Factor	All filters except 10 Hz and 200 kHz are three-pole Butterworth; de-emphasis time constant and 3 dB filter frequencies have accuracy of $\pm 4\%$ (except 10 Hz).															

PERFORMANCE SPECIFICATIONS

<i>Parameter</i>	<i>Specifications</i>
Audio Distortion	Less than 0.1% total harmonic distortion for + 100 kHz deviation Less than 0.2% total harmonic distortion for 30% AM Less than 0.5% total harmonic distortion for 90% AM (f_{mod} less than 100 kHz)
Audio Output Level	1 V rms nominal into 600-ohm load at 1000 counts on digital panel meter (DPM).
Annunciators	Back lighted display of all switch settings. LEVEL high (▲) and LEVEL low (▼); LOCK flashes when instrument is unlocked; RANGE flashes when display is overranged.
Power Requirements	100, 120, 220, or 240 V AC, 50 to 400 Hz.
IF OUT (front panel): Frequency Level	1 MHz nominal 0.223 V rms nominal into 50-ohm load.
DC OUT (rear panel)	1.00 V DC from 1000-ohm source at 1000 counts on DPM.
Display (front panel) Modulation	4-digit LED display; 1000counts + 100% overrange; true peak, \pm peak, or peak average indication.
FM Resolution:	
300 kHz Range	1 kHz
100 kHz Range	100 Hz
10 kHz Range	10 Hz
AM Resolution:	
300% Range	1%
100% Range	0.1%
10% Range	0.01%
Operating Temperature	0°C to 55°C (32°F to 105°F)

Section III. Technical Principles of Operation

PRINCIPLES OF OPERATION

Introduction

a. AM/FM Modulation Meter ME-525A/USM is a compact, solid-state amplitude modulation (AM) and frequency modulation (FM) modulation meter that covers the carrier frequency range of the signal under test from 0.01 to 1.2 GHz. Amplitude or frequency modulation is displayed on a four-digit light-emitting diode (LED) display, which provides a maximum resolution of + 10 Hz deviation or 0.01% AM.

b. Operation of the ME-525A/USM is fully automatic. The largest signal present at the RF IN connector is converted to a 1.0 MHz intermediate frequency signal, which is automatically leveled. With a fixed carrier level, the modulation depth of AM signals is directly proportional to the peak amplitude of the recovered audio. The deviation of an FM signal is also directly proportional to the peak amplitude of the recovered audio. The modulation component of the input signal is recovered and converted to a proportional dc level, which drives the four-digit LED display to provide calibrated indications of amplitude modulation or frequency modulation. IF level may also be displayed. Pushbutton selection of baseband filtering assures accurate modulation readout with minimum residual modulation error.

2. Simplified Block Diagram

a. General. For purposes of this discussion, the circuits of the ME-525A/USM can be grouped by function as follows:

- radio frequency circuits
- frequency modulation circuits
- amplitude modulation circuits
- audio circuits
- digital panel meter (DPM) circuits
- logic circuits
- power supply circuits

PRINCIPLES OF OPERATION

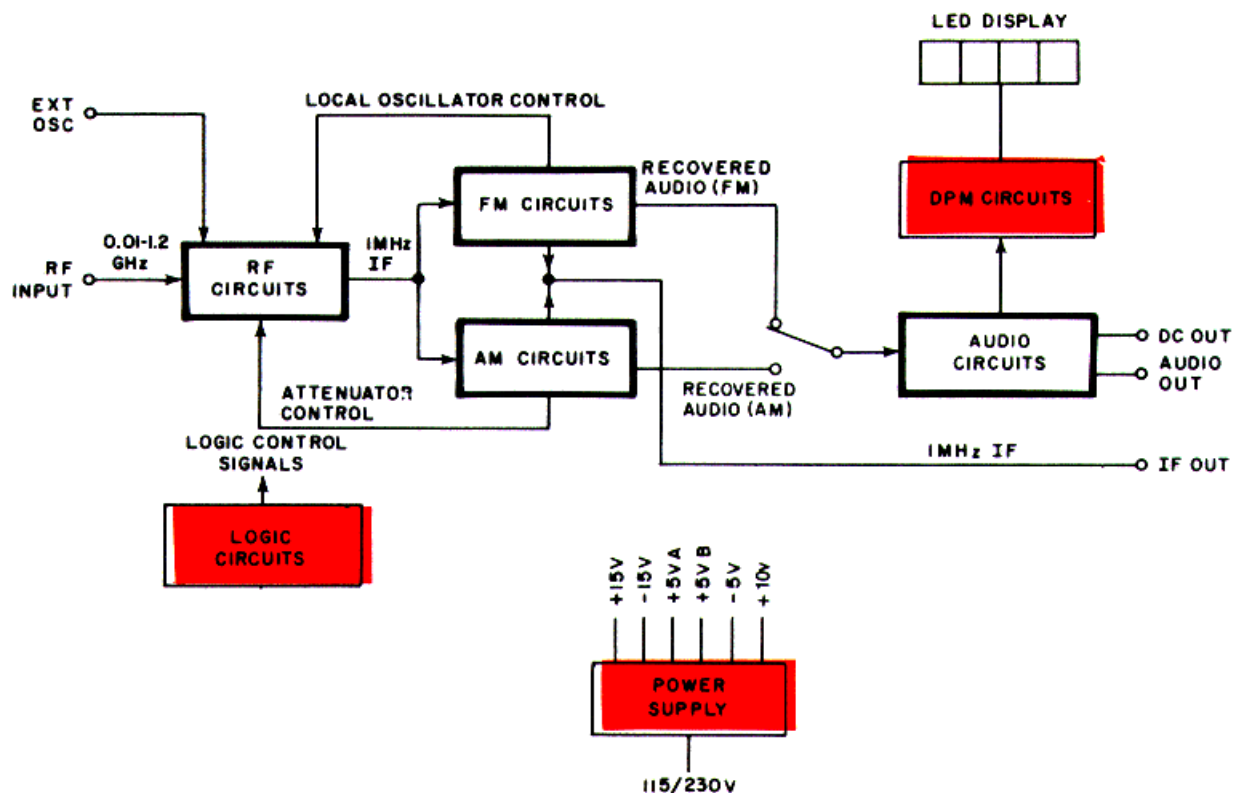

b. *Radio Frequency (RF) Circuits.* The **RF IN** signal to be measured is connected to the radio frequency circuits through a front panel **RF IN** connector. Within the rf circuits the input signal is applied through an electronically controlled attenuator to a sampling mixer. The attenuator is controlled by a signal from the amplitude modulation (AM) circuits, and it is effective for input signals above approximately 100 millivolts rms. Attenuation prevents sampling mixer overload. The sampling mixer mixes the input signal and signal supplied either from an internal oscillator or from an external source (EXT OSC) as selected by the operator, to produce a 1.0 M Hz intermediate frequency signal. If the internal oscillator is selected, the oscillator frequency is swept over the oscillator tuning range automatically by the frequency modulation circuits until frequency lock (1.0 MHz intermediate frequency) is attained; the oscillator frequency is then maintained precisely at this point by the local oscillator control in the frequency modulation circuits. If the external source is selected, the external oscillator must be set precisely to a frequency that will produce the 1.0 MHz intermediate frequency when mixed with the radio frequency input signal. The 1.0 MHz intermediate frequency signal developed by the sampling mixer is supplied to the amplitude modulation circuits and to the frequency modulation circuits.

PRINCIPLES OF OPERATION

c. *Amplitude Modulation (AM) Circuits.* The 1.0 MHz intermediate frequency signal from the sampling mixer is coupled to amplifier circuits through a flat-amplitude, low-pass filter. An electronic variable attenuator ensures that a constant intermediate frequency signal level is maintained at the input of a linear active detector circuit, which recovers the amplitude modulation component of the intermediate frequency signal. Additional filtering removes unwanted signals from the recovered audio. Constant AM channel gain is maintained through an agc amplifier, driven by a dc output signal from the detector circuit. The agc amplifier controls the attenuators in the amplitude modulation circuits and the radio frequency circuits. The recovered audio is supplied to the audio circuits. A leveled intermediate frequency signal is also supplied by the amplitude modulation circuits to the front panel IF OUT connector when the % **AM** or **LEVEL FUNCTION** is selected.

NOTE

The preceding description of attenuator control assumes that the front panel **FUNCTION LEVEL SET TO 10.00-AUTO** control is set to the **AUTO** position. If the **LEVEL** control is switched from the **AUTO** position, manual adjustment of attenuator control signals, using the **LEVEL** control, is possible.

d. *Frequency Modulation (FM) Circuits.* The 1.0 MHz intermediate frequency signal from the sampling mixer in the radio frequency RF circuits is coupled to a limiting circuit through a flat-delay, low-pass filter. The limiting circuit prevents amplitude modulation of the intermediate frequency (IF) signal from affecting the frequency modulation (FM) detector circuits. The FM detector circuit is a pulse-counting frequency discriminator. The linearity of this circuit insures accurate, low distortion detection of FM signals. The recovered audio signal is coupled to the audio circuits through additional filters that remove unwanted signals from the recovered audio. The frequency modulation (FM) circuits also contain search circuitry which supplies the local oscillator control signal to the radio frequency RF circuits for automatic tuning of the local oscillator. This control signal tunes the local oscillator automatically, as required, to attain the 1.0 MHz intermediate frequency. Once frequency lock has been attained, the frequency of the local oscillator is held constant by a dc output from the FM detector circuit in the frequency modulation (FM) circuits. The limited intermediate frequency (IF) signal from the frequency modulation circuits is available at the front panel **IF OUT** connector when the **FUNCTION kHz DEV** has been selected.

e. *Audio Circuits.* The recovered audio signal from the amplitude modulation (AM) circuits or the frequency modulation (FM) circuits, as determined by the selected function, is supplied to the audio circuits. Baseband processing circuitry in the form of cascadable high-pass and low-pass or de-emphasis filters allows precise control of post-detection bandwidth. The baseband circuitry also contains additional amplification and precision peak detectors. The precision peak detectors convert the recovered audio into a proportional dc signal, which is supplied to the digital panel meter (DPM) circuits.

PRINCIPLES OF OPERATION

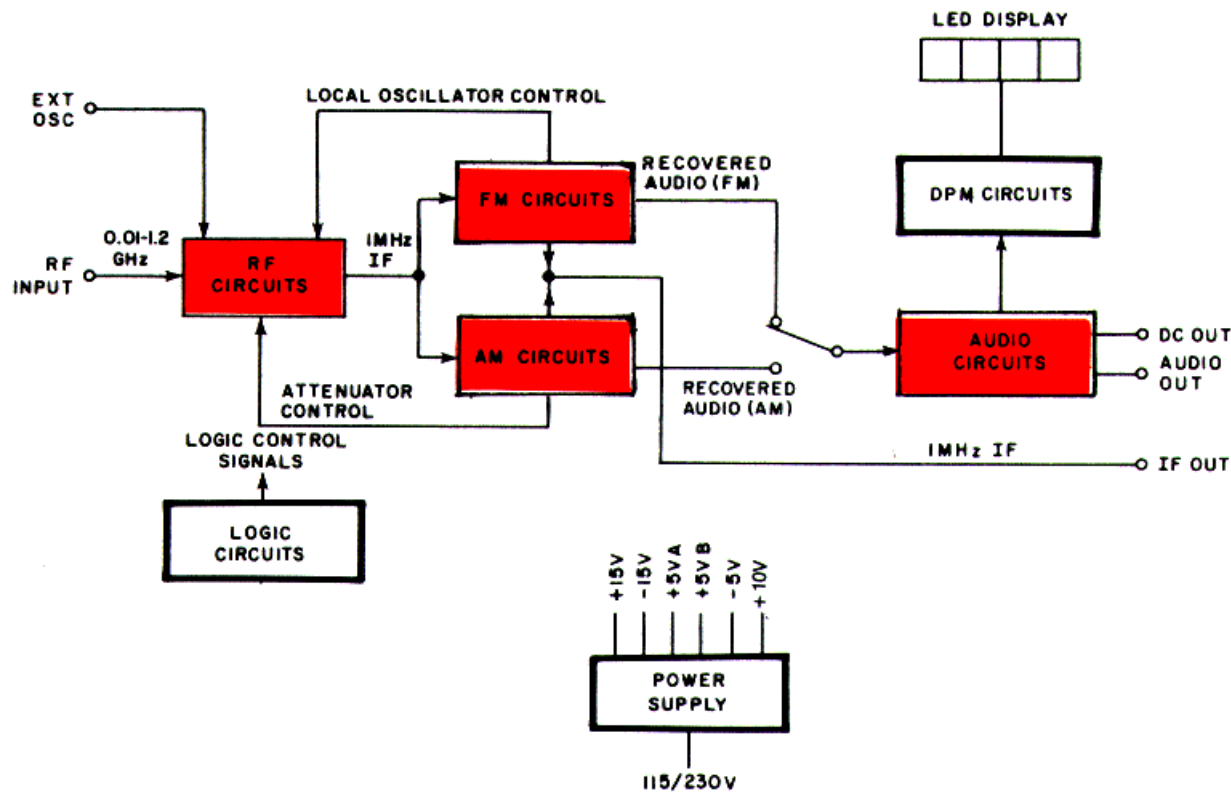

f. *Digital Panel Meter(DPM) Circuits.* The dc signal information supplied by the audio circuits is converted to a four-digit display by a precision, dual slope integrator. Multiplexed display signals drive the LED display on the front panel. Proper display decimal point location is determined automatically by logic circuitry. If the LED display circuits should overrange, an overrange signal is supplied to the logic circuits.

g. *Logic Circuits.* The logic circuits convert the front panel switch signals to 5-volt, CMOS-compatible control signals. These signals are supplied to individual circuits of the ME-525A/USM through a three-state instrument control bus. The logic circuits also generate multiplexed signals which illuminate control and status annunciators on the front panel.

h. *Power Supply Circuits.* The power supply circuits provide regulated, dc voltages. Six power supplies are required: + 15-volt, + 10-volt, 15-volt, 5-volt, + 5-volt (A), and + 5-volt (B). Two separate + 5-volt supplies are used to power the analog and digital sections of the M E-525A/USM to ensure the lowest possible residual modulation.

CHAPTER 2
OPERATING INSTRUCTIONS

Section I.	Controls and Indicators	Page 2-1
Section II.	Preventive Maintenance Checks and Services (PMCS)	2-5
Section III.	Operation Under Usual Conditions	2-7
Section IV.	Operation Under Unusual Conditions	2-19

Section I. Controls and Indicators

FUNCTION OF CONTROLS AND INDICATORS

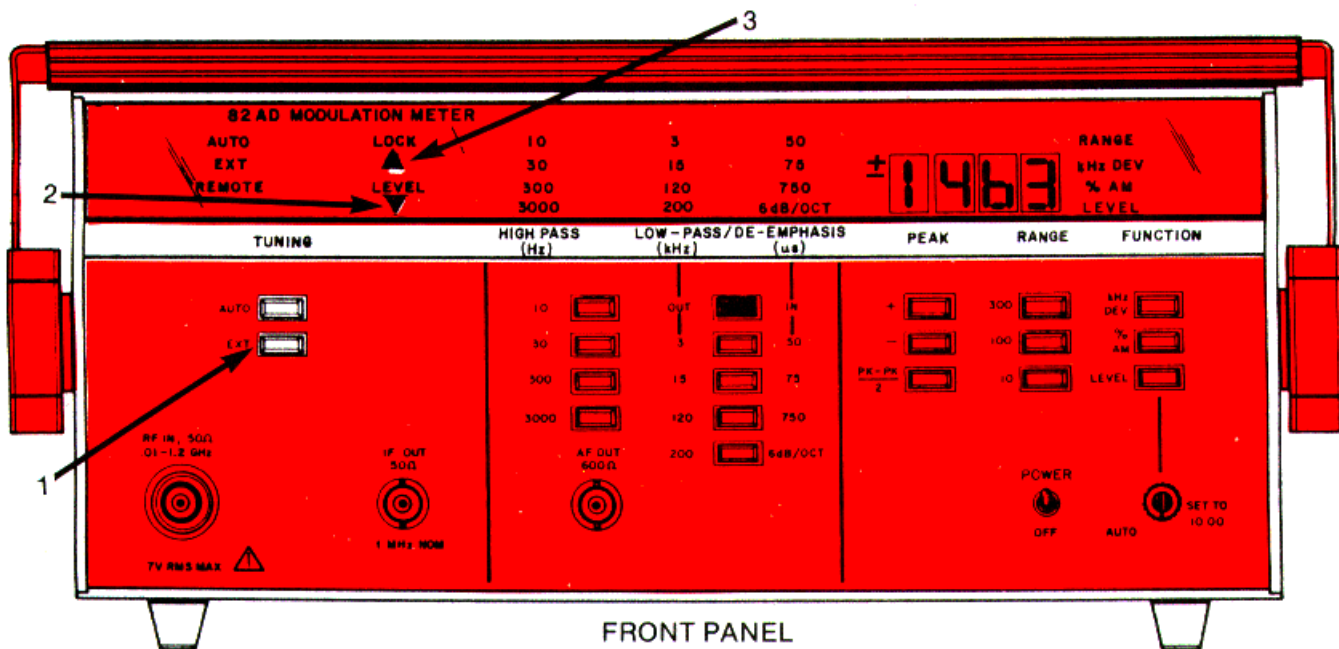

NOTE: ALL INDICATOR ANNUNCIATORS ARE SHOWN ON

Item No.	Control or Indicator	Function
1	TUNING AUTO-EXT switches	Permit operator to select automatic (AUTO) or external (EXT) tuning. Lighted annunciators indicate switch selection.
2	LEVEL low (▼) annunciator	Word LEVEL and (▼) are illuminated when input level is too low for accurate modulation measurements.
3	LEVEL high (▲) annunciator	Word LEVEL and (▲) are illuminated when input level is too high for accurate modulation measurements.

FUNCTION OF CONTROLS AND INDICATORS

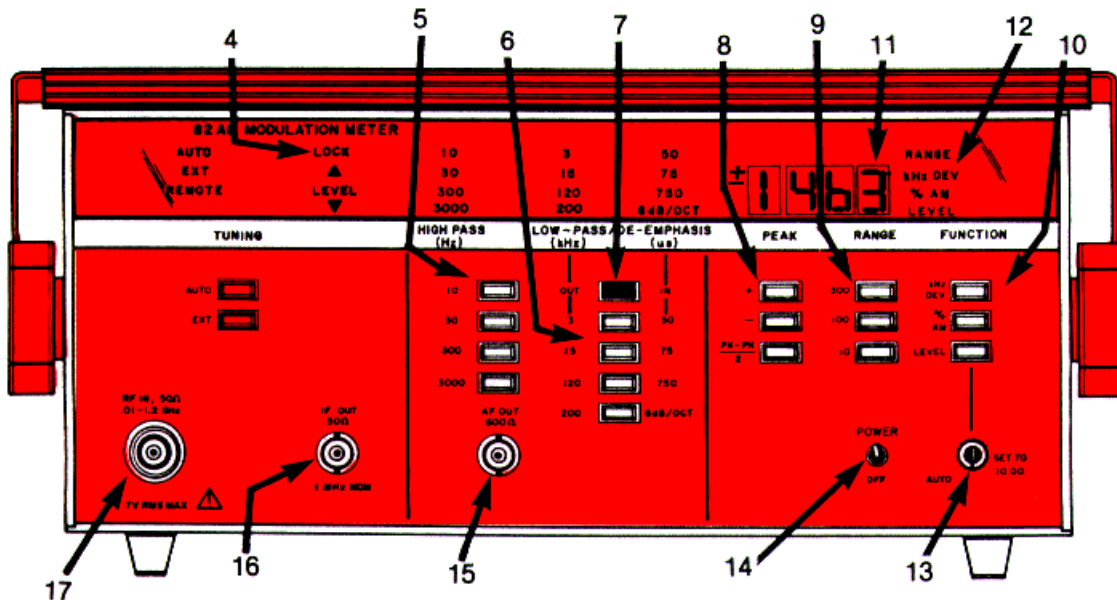

NOTE: ALL INDICATOR ANNUNCIATORS ARE SHOWN ON

Item No.	Control or Indicator	Function
4	LOCK annunciator	Flashes when ME-525AIUSM is out of lock; stops flashing when lock is achieved. LOCK is the condition when the local oscillator produces a 1.0 MHz if. signal.
5	HIGH-PASS (Hz) switches	Permit operator to select one of four high-pass baseband filters (10, 30, 300, or 3000 Hz). Lighted annunciator indicates switch selection.
6	LOW-PASS (kHz)DE-EMPHASIS (us) switches	Permit operator to select one of four low-pass or de-emphasis filters (3, 15, 120, 200 kHz or 50, 75, 750 us or 6 dB/OCT (per octave)), depending on position of OUT-IN switch. Lighted annunciator indicates switch selection.
7	LOW-PASS (kHz)DE-EMPHASIS	Alters operation of switches (Item 6 above) from LOW-PASS (OUT) to DE-EMPHASIS (IN) . Lighted annunciator indicates switch selection.

Item No.	Control or Indicator	Function
8	PEAK switches	Permit operator to select a display of + peak (FM or AM), - peak (FM or trough of AM), or PK - PK (peak average). 2 Lighted annunciator indicates switch selection.
9	RANGE switches	Permit operator to select desired full-scale modulation range (10, 100, or 300 kHz deviation, or 10, 100, or 300% AM).
10	FUNCTION switches	Permit operator to select display function (kHz DEV, % AM, or LEVEL). Lighted annunciator indicates switch selection.
11	LED display	Indicates modulation (kHz DEV or % AM), or if level, as determined by FUNCTION switch selection, by means of 4-digit LED display.
12	RANGE annunciator	Flashes when digital display is overranged.
13	SET TO 10.00 - AUTO control	Permits operator to select automatic or manual if. level set for AM measurements.
14	POWER OFF switch	Permits operator to control application of AC power.
15	AF OUT connector	Provides means for connecting recovered audio signal to external equipment.
16	IF OUT connector	Provides means for connecting if. signal to external equipment.
17	RF IN 50-ohm connector 	Provides means for connecting input signal to input circuits. Input signal must not exceed 7V rms.

 This safety requirement symbol directs that it is necessary to refer to the instruction manual.

FUNCTION OF CONTROLS AND INDICATORS

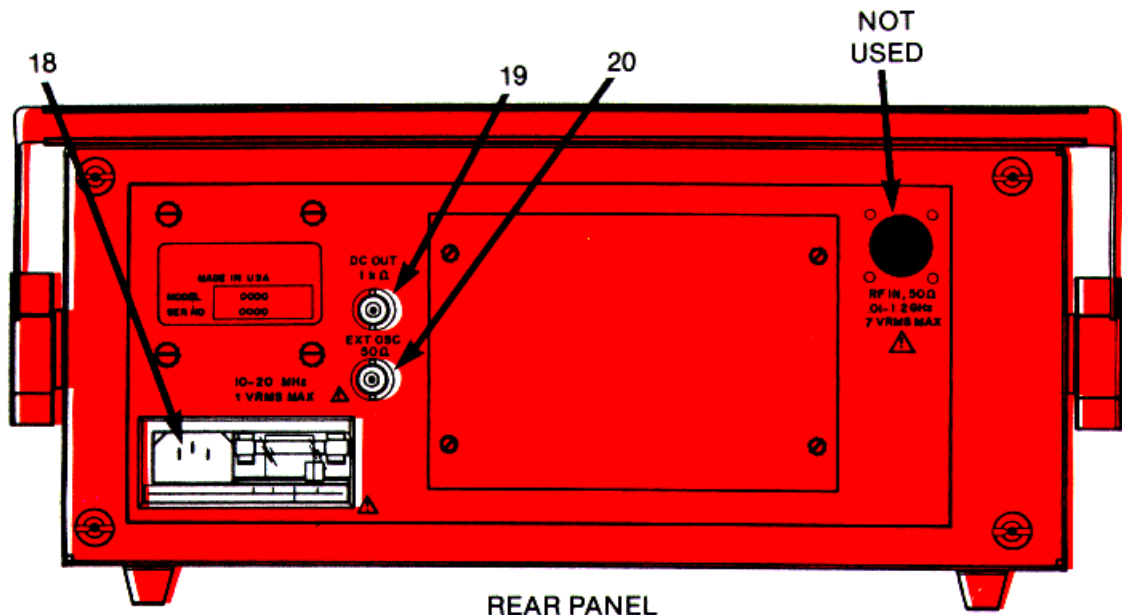

<i>Item No.</i>	<i>Control or Indicator</i>	<i>Function</i>
18	Power connector, AC line voltage ⚠	Provides means for connecting AC power. Also contains line voltage programming circuit board and line fuse. Verifies proper ac power connection.
19	DC OUT 1K-ohm connector	Provides means for connecting external voltmeter to voltage that drives internal LED display.
20	EXT OSC 50 ohm connector	Provides means for connecting external local oscillator signal.

Section II. Preventive Maintenance Checks and Services (PMCS)

PMCS INTRODUCTION

- **Before (B) you operate.** Always keep in mind the WARNING contained inside the cover of this manual and the CAUTIONS given in the operating procedures.
- **During (D) operation.** Always keep in mind the WARNING and CAUTIONS mentioned above.
- **After (A) you operate.** Be sure to perform the after (A) operation PMCS procedures.
- **Routine checks.** Routine checks such as cleaning, dusting, stowing items not in use and checking for loose nuts, bolts, mounting and the like are not listed as PMCS checks. You should do these things anytime you see they must be done.

NOTE

Use the ITEM NO. column in your PMCS table to get the numbers for the **TM ITEM NO.** column on DA Form 2404 (Equipment Inspection and Maintenance Worksheet) when you fill out the form.



TM ITEM NO. a	STATUS b	DEFICIENCIES AND SHORTCOMINGS c	CORRECTIVE ACTION d	INITIAL WHEN CORRECTED e
5		LOCK DISPLAY BLINKS	SCHEDULED FOR EVALUATION	

DA FORM 2404
JAN 64

PMCS CHART

Item No.	Interval			Item to be Inspected	Procedures Check for and have repaired or adjusted as necessary	Equipment is not ready/available if:
	B	D	A			
1	•			Ac input power on rear panel.	Verify voltage amplitude of available ac power, 115 or 230 volts ac.	Power not available at proper amplitude and frequency.
2	•			Fuse	Check fuse for proper rating of: 115 volts ac 0.5 ampere 230 volts ac 0.25 ampere.	Proper fuse not available.
3	•			120-240 volt ac circuit board	As seen from behind rear panel, 120 or 240 is in view.	PC board not present or damaged so that proper primary power range cannot be set.
 <p>CIRCUIT BOARD</p>						
4	•	•		Indicator panel of ME-525A/USM.	Insert board to correspond to primary voltage available (100 or 120) or (220 or 240) Indicator panel displays the data selected by front panel pushbutton switches. Verify that pushbuttons illuminate proper displays.	Higher level of maintenance required if display is absent.
5		•		Lock display begins to blink	Verify RF IN signal is present and of proper amplitude.	RF IN signal is not present and not of proper amplitude.
6			•	ME-525A/USM	Store ME-525A/USM. Examine power cable and test cables for damage or wear.	

Section III. Operation Under Usual Conditions

INITIAL CONNECTIONS AND ADJUSTMENTS

- The ac power cable is the only cable and connectors furnished with the M E-525A/USM. This connects at the rear panel and ac power source.

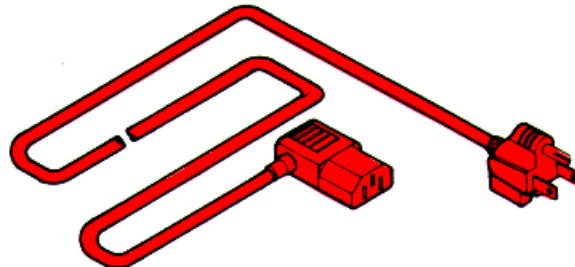

CAUTION

Always make certain that the line voltage ac circuit board in the power connector is installed for the available ac line voltage, and that a fuse of the proper rating (0.5 A for 100 to 120 volts, and 0.25 A for 200 to 240 volts) is installed in the fuse holder before connecting to any ac power source.

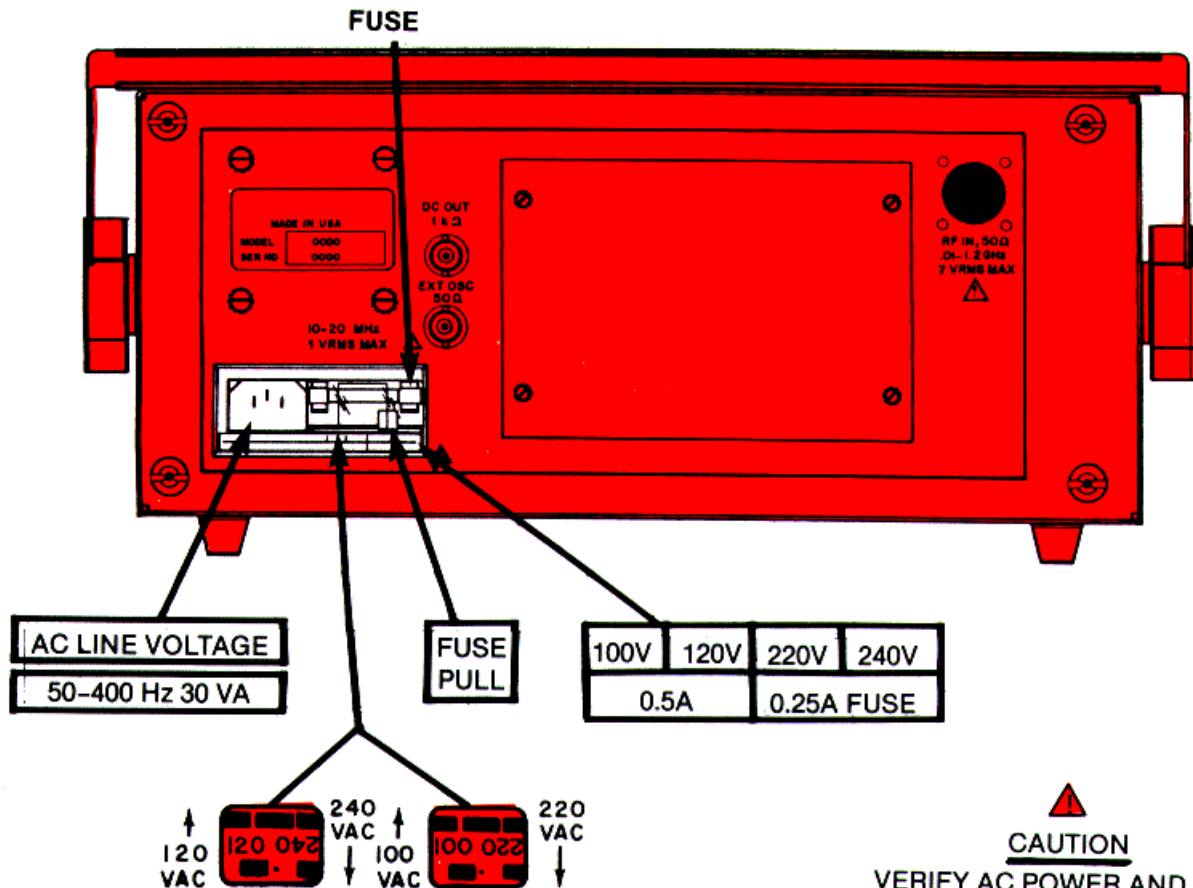

CAUTION
VERIFY AC POWER AND FUSE
BEFORE CONNECTING

INITIAL CONNECTIONS AND ADJUSTMENTS

- Other connections to the ME-525A/USM are given below with the type of connector required at the ME-525AIUSM. Connector (or connections) required at the unit (signal source) under test will not be the same for all applications.

RF IN The RF IN connector is a type N connector. Input impedance is 50 ohms nominal. The maximum amplitude (rms) to be applied to the RF IN input is 7.0 volts (1.0 watt).

IF OUT The IF output is available at the front panel IF OUT connector (type BNC). The level is approximately 0 dBm, and the nominal source impedance is 50 ohms.

AF OUT The recovered audio signal is available at the front panel AF OUT connector (type BNC). The level is 1 volt rms at 1000 counts on the digital panel meter display, and the source impedance is 600 ohms.

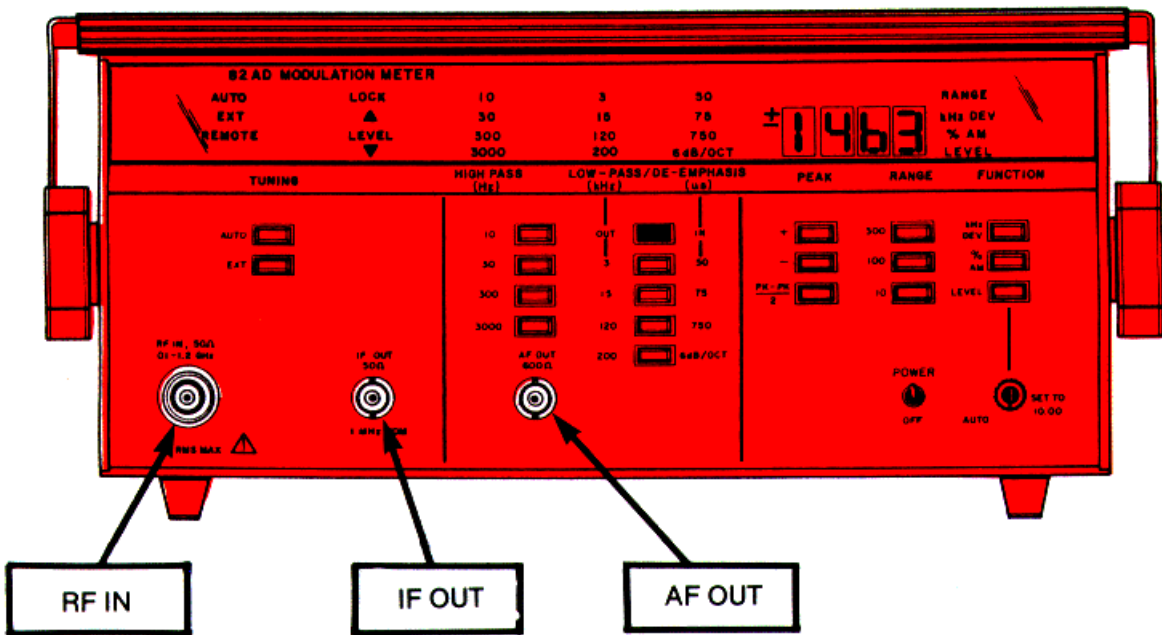

FRONT PANEL

INITIAL CONNECTIONS AND ADJUSTMENTS

EXT OSC An external local oscillator signal may be applied to the OSC connector (type BNC) on the rear panel of the ME-525A/USM. The input impedance is approximately 50 ohms, and the required level is 1.0 millivolt (0 dBm).

DC OUT A DC output signal, proportional to the digital panel meter display, is available at the rear panel DC OUT connector (type BNC). This output signal is 1.000 V (1 volt) at 1000 counts on the digital panel meter display. Source impedance is 1.0 K (1 kilohm).

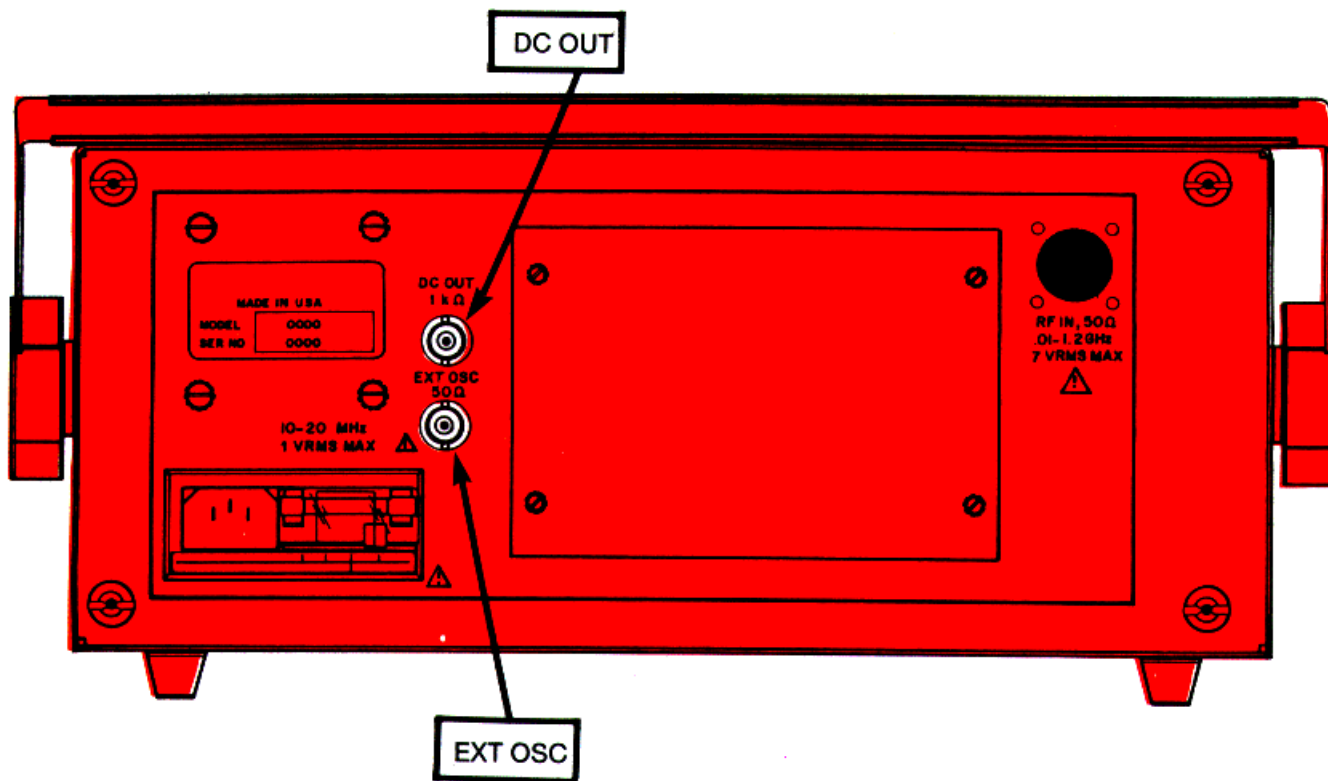

REAR PANEL

PRELIMINARY OPERATIONAL CHECKS

The following steps are to check that the front panel switches provide the proper indications on the front panel indicators.

- Step (1)** Place the **POWER-OFF** switch in the **POWER** position. Random indication appears.
- Step (2)** With **TUNING AUTO** and **EXT** switches out, **AUTO** appears on indicator, **LOCK** blinks and **LEVEL ▲** or **LEVEL ▼** may light.
- Step (3)** Depress **TUNING AUTO** switch. Same indications as in step (2) above are displayed.

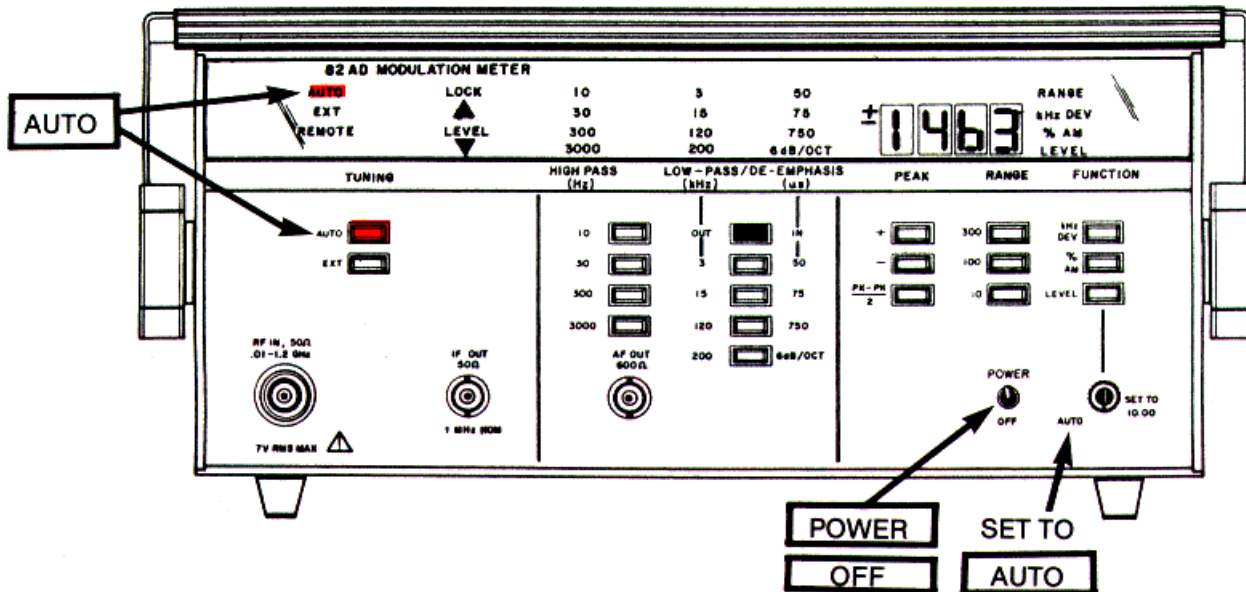

- Step (4)** Depress **TUNING EXT** switch. Same as steps (1) and (2) above except **EXT** is displayed instead of **AUTO**.

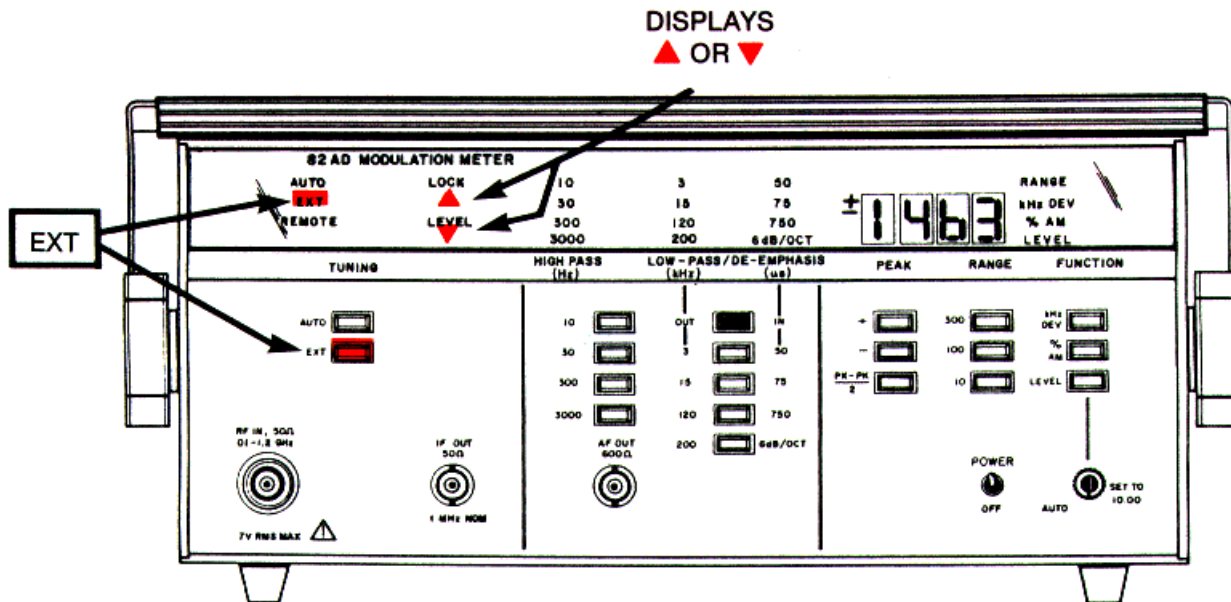

PRELIMINARY OPERATIONAL CHECKS

- Step (5)** If all switches under **HIGH-PASS(HZ)** are out, **10** is displayed. Press **10** switch, **10** remains displayed. Press **30**, **300** and **3000** in turn. Each number in turn will be displayed.
- Step (6)** If all switches under **LOW-PASS/DE-EMPHASIS (kHz)(uS)** are out, **3** is displayed. With the green **OUT-IN** switch out, press **3**, **15**, **120** and **200** switches in turn. Respective numbers are displayed. Press green **OUT-IN** switch in. **6 dB/OCT** is displayed. In turn press **750**, **75** and **50** switches. Respective numbers will be displayed.

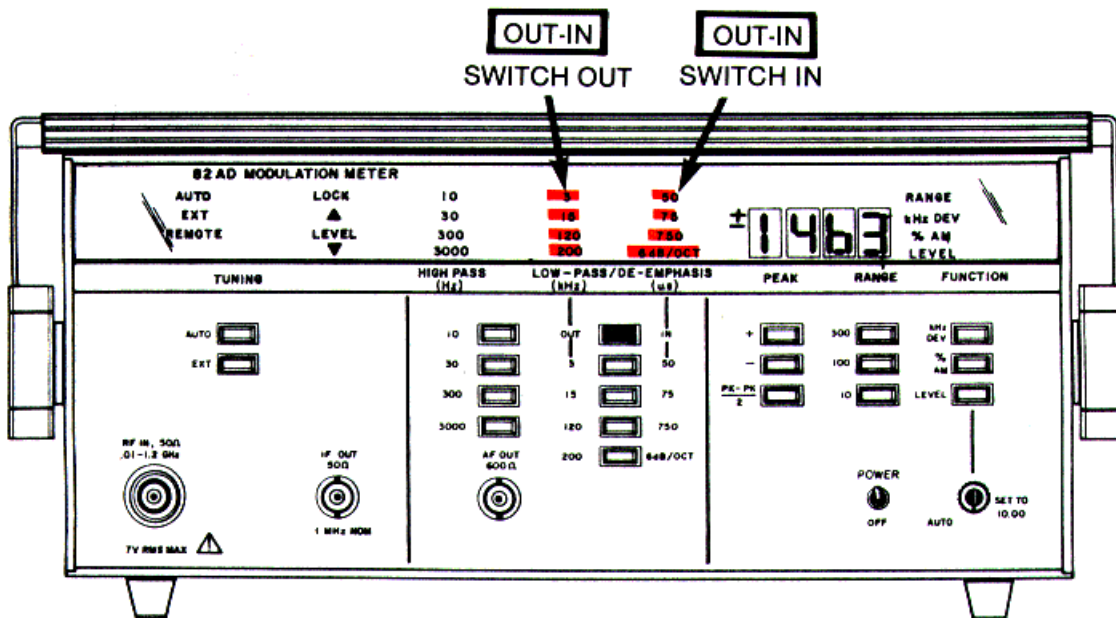

- Step (7)** If all **PEAK** switches are out, a **+** is displayed. Press the **+** switch and a **+** is displayed, press the **-** switch and a **-** is displayed. Press **PK - PK** switch and a **±** is displayed.

2

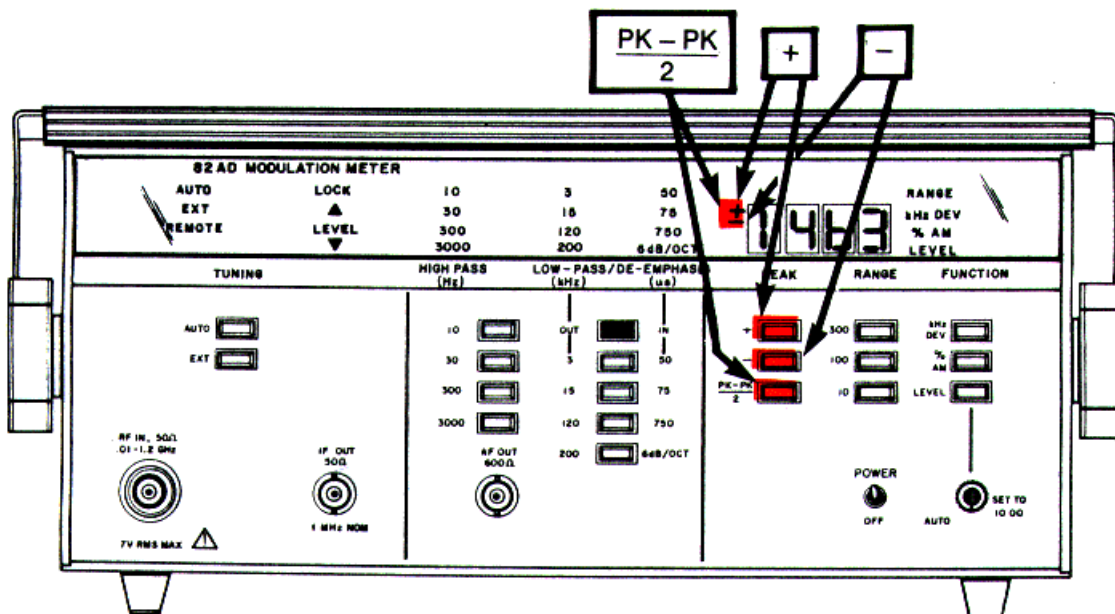

PRELIMINARY OPERATIONAL CHECKS

Step (8) If all the **RANGE** switches are out or the **10** switch is depressed a four digit random display is presented with the decimal point indicating hundredths (**NN.NN**). With the **100** switch depressed the display indicates tenths (**NNN.N**). With the **300** switch depressed the display indicates a whole number (**NNNN**).

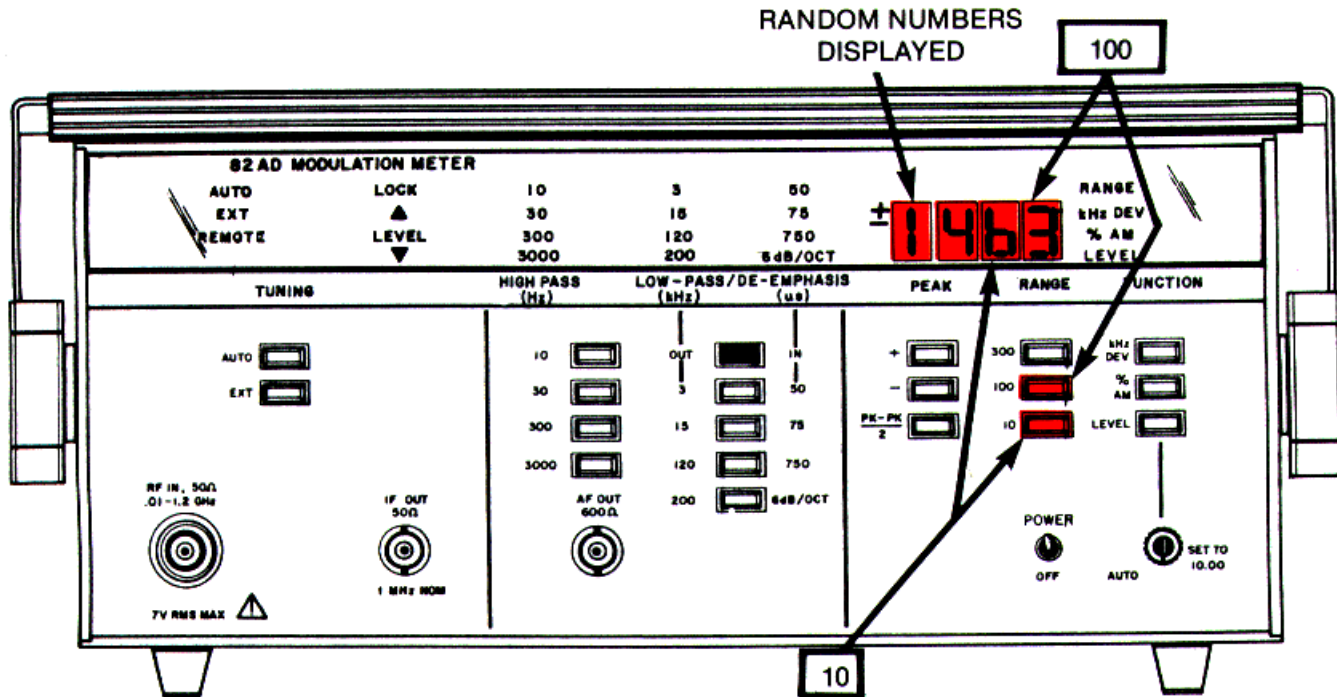

Step (9) If **FUNCTION** switches are out **kHz DEV** is displayed and **RANGE** may flash. Depress **kHz DEV**, **% AM** and **LEVEL** switches in turn and **kHz DEV**, **% AM** and **LEVEL** respectively are displayed. **RANGE** may also momentarily flash with **% AM** depressed. Depress **LEVEL** switch and **LEVEL** indicator will display.

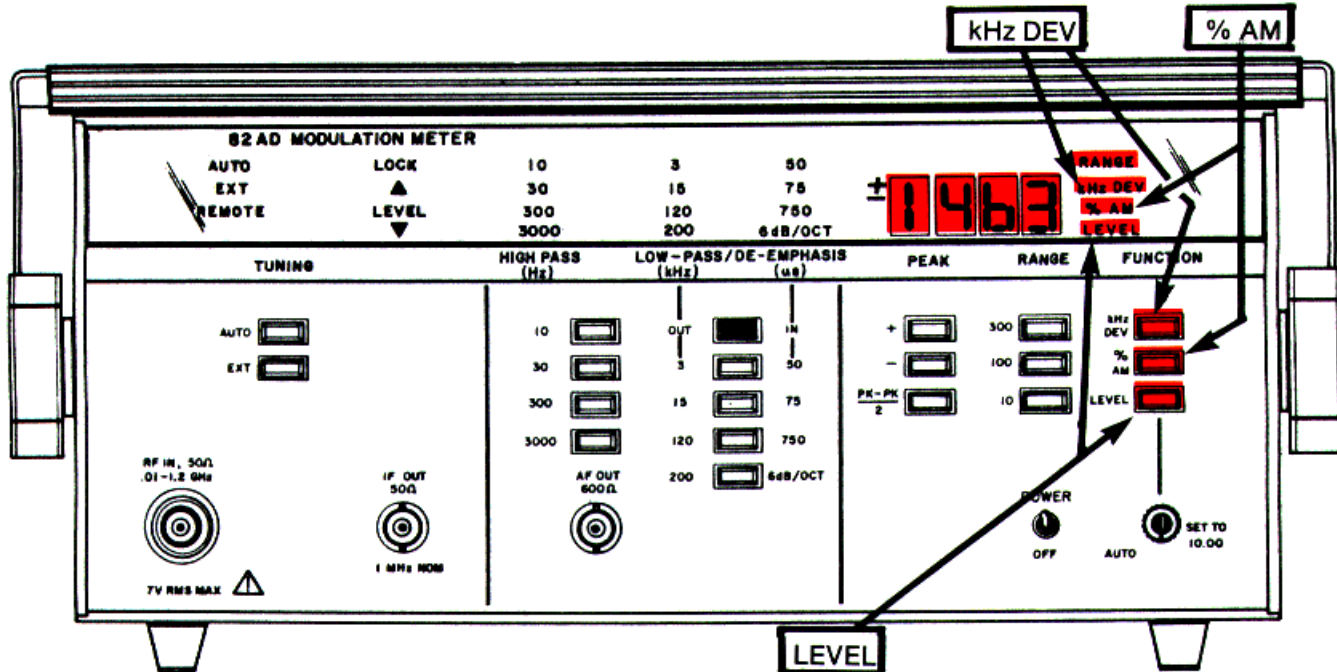

Step (10) If **AUTO-SET TO 10.00** control is rotated CW and CCW a random display will appear. This control should always remain in the "AUTO" position.

PRELIMINARY INFORMATION

- FM Measurements**

FM measurements for modulating frequencies from 30 Hz to 100 kHz and deviations up to ± 300 kHz peak-to peak can be made. To achieve maximum accuracy, the signal level applied to the RF input should be greater than 100 millivolts. This reduces residual FM within the ME-525A/USM to a minimum value. To further reduce residuals, the minimum measurement bandwidth consistent with the modulation frequency should be used. For instance, for measurements at a 1-kHz modulation rate, the 300 Hz 3 kHz bandwidth should be used. Because the audio detectors are true peak responding, the residual noise is added directly to the recovered signal being measured. True rms measurements of the recovered audio signal available at the front panel connector will provide a more precise indication of modulation in the presence of noise. Because of the low residual FM characteristics of the ME-525A/USM, direct measurements of residual FM are possible. To obtain a meaningful indication of the combined noise of the ME-525A/USM and the device under test, true rms measurement is suggested. Accurate measurements of the ME-525A/USM noise characteristics are made by driving the RF input with a crystal source at the desired RF frequency and a level exceeding 100 millivolts rms. Note that the LED display will respond to the highest noise peaks.

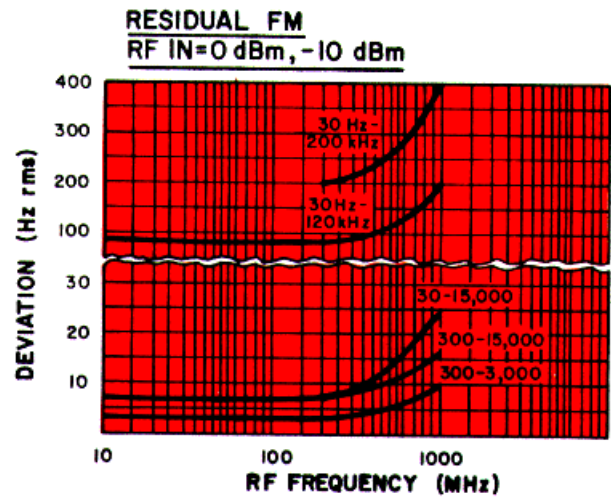
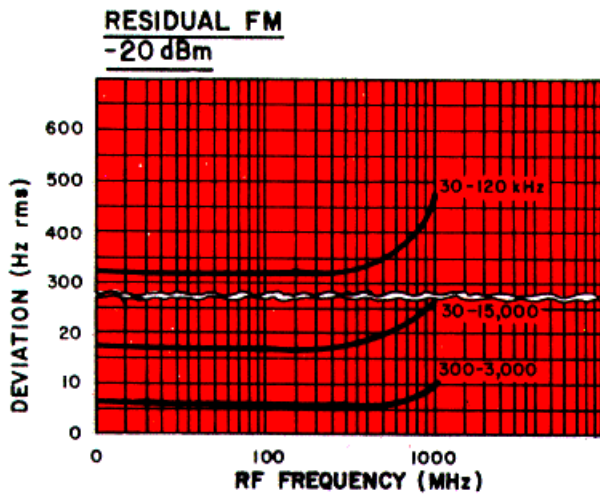

Typical Residual Response

PRELIMINARY INFORMATION

- **AM Measurements**

The ME-525A/USM makes possible fast, accurate measurements of amplitude modulation. Optimum accuracy is achieved by using an input signal level between 100 and 1000 millivolts rms (lowest residuals), and minimum measurement bandwidth consistent with the modulation frequency used. True rms measurement of the recovered audio output at the connector on the front panel of the ME-525A/USM will improve measurement accuracy in the presence of noise and/or distortion.

- **High Percentage AM Measurements**

Difficulties may be experienced when attempting to measure AM modulations approaching 100%. The ME-525A/USM automatically searches for, and locks onto the highest carrier level between 10 MHz and 1.2 GHz. If this carrier is amplitude-modulated the carrier tends to disappear in the troughs of modulation as the percentage of AM approaches 100%. This causes the ME-525A/USM to lose lock and start a search for a higher level carrier. The point at which frequency lock is lost is a function of carrier frequency and level. Worst case occurs at low frequencies at low levels where lock can be lost at approximately 93% of AM. The situation improves to approximately 98% at high carrier frequencies and levels.

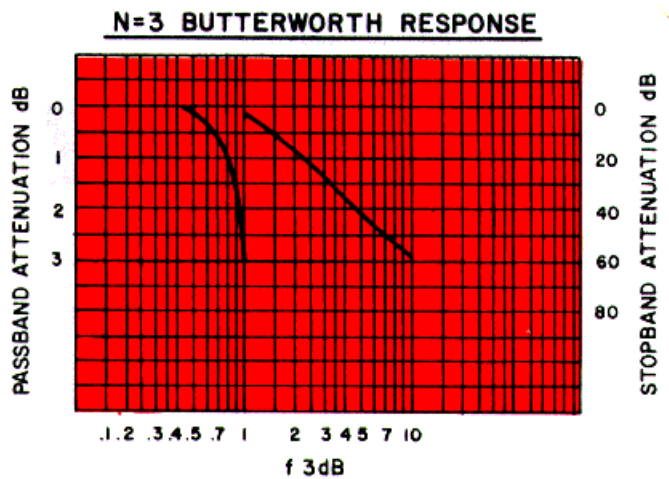
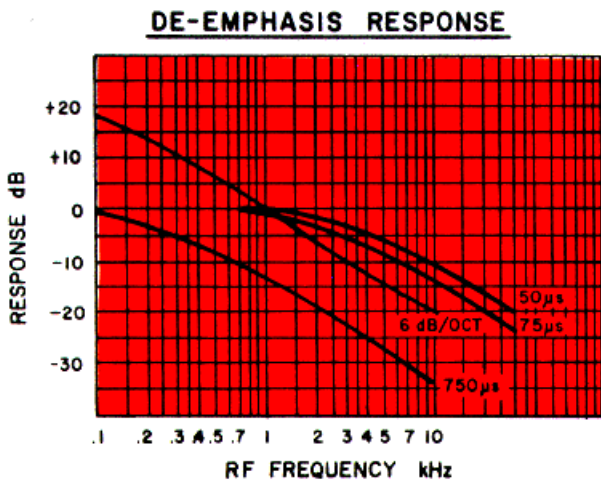

TYPICAL AUDIO RESPONSE

PRELIMINARY INFORMATION

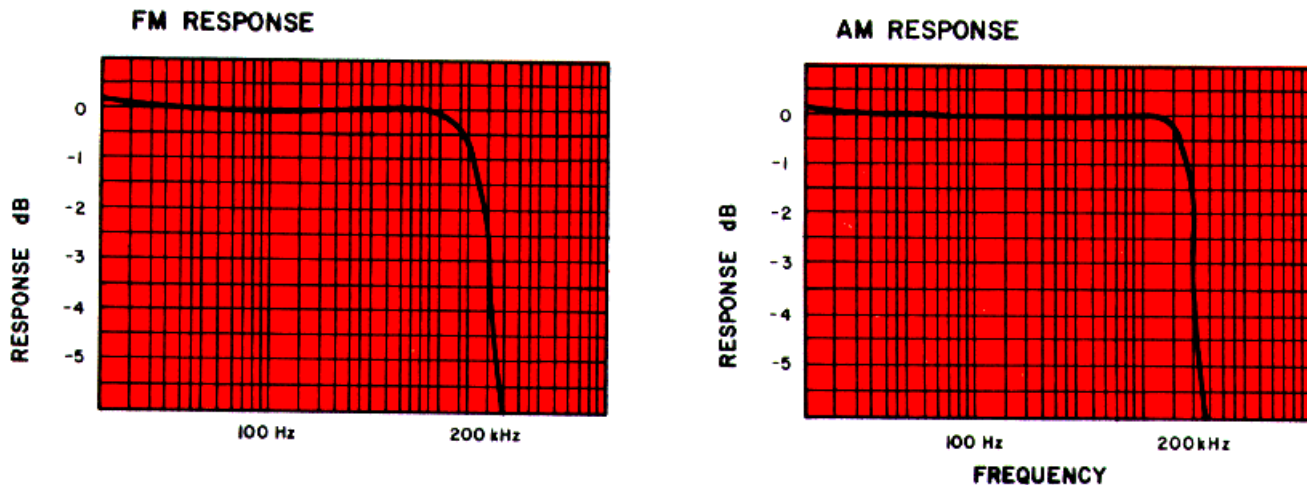

TYPICAL AUDIO RESPONSE

- **Front-End Preselection**

The noise and spurious response can be improved by using front-end preselection. For example, if measurements are confined to an RF input bandwidth of 88 to 108 MHz, a filter as shown below will remove undesired RF signals outside this band. The filter may be installed externally, or behind the front panel of the ME-525A/USM.

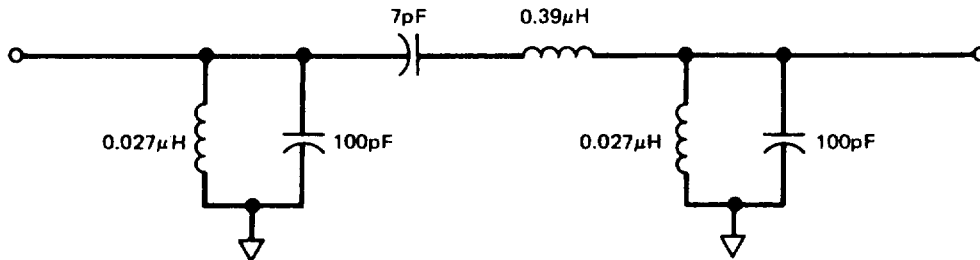

Typical Front-End Preselection Filter

AM MEASUREMENT

Step (1) Place **POWER-OFF** switch in **POWER** position and allow 1 minute warmup

NOTE

In steps (2) through (4) and (6) below the annunciators will light as the switches are depressed.

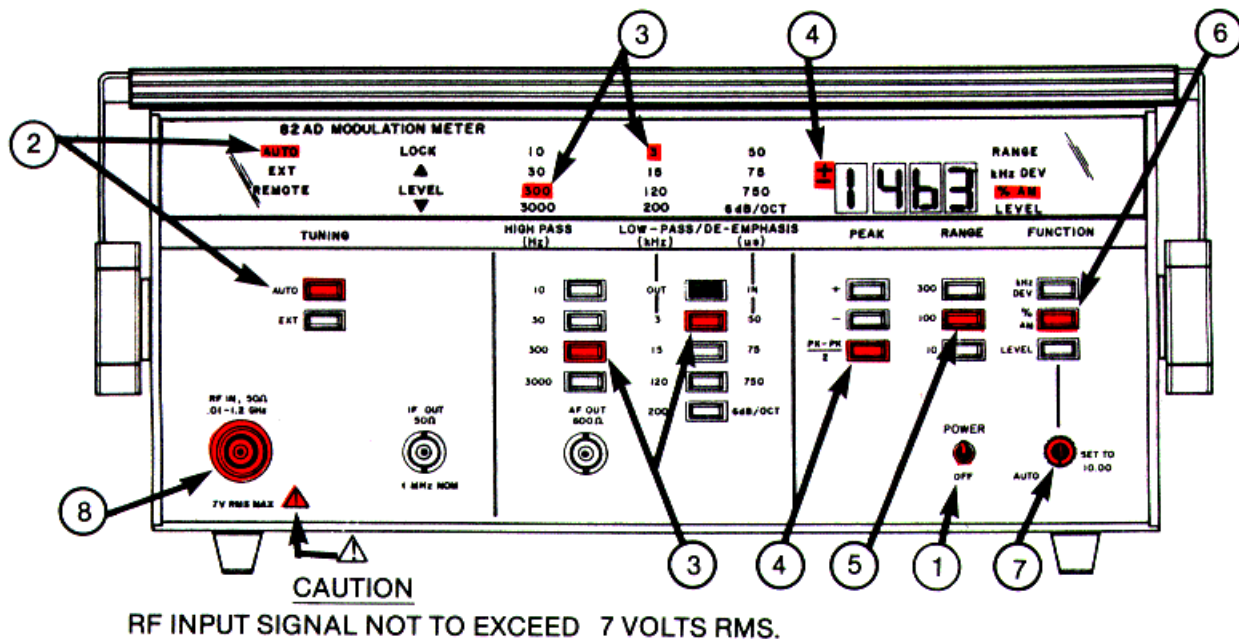

Step (2) Depress the **TUNING AUTO** switch.

Step (3) Select the desired measurement bandwidth, using the minimum bandwidth consistent with the modulating frequency. For example, for measurements involving a 1 kHz modulating signal, select a measurement bandwidth of 300 Hz to 3 kHz. Select the low frequency end by depressing the appropriate **HIGHPASS (Hz)** switch. Actuate the **LOWPASS (kHz)YDE-EMPHASIS (us) OUT-IN** (green) switch to the out position, and select the high frequency end by depressing the appropriate **LOWPASS (kHz)YDE-EMPHASIS (us)** switch (**3, 15, 120 or 200**).

Step (4) Depress the appropriate **PEAK** switch, as determined by the AM modulation measurement to be made. A positive(+) peak, negative (-) peak, or peak average display can be selected by depressing the **PEAK +**, **PEAK -**, or **PK-PK** switch, respectively (**PEAK-PEAK** shown).

Step (5) Depress the **RANGE 100** switch.

Step (6) Depress the **FUNCTION % AM** switch.

Step (7) Turn the **AUTO-SET TO 10.00** control fully counterclockwise (ccw) to the **AUTO** position.

Step (8) Connect the rf signal to be measured to the **RF IN** connector.

Step (9) The **LOCK** annunciator will stop flashing and the **LEVEL** (signal ▼) annunciator will extinguish if the rf level of the input signal is within the correct level range and the frequency of the input signal is within the acceptable frequency range.

Step (10) Read the % AM directly from the LED display.

FM MEASUREMENT

Step (1) Place **POWER-OFF** switch in **POWER** position.

NOTE

In steps (2) through (4) and (6) below the annunciators will light as the switches are depressed.

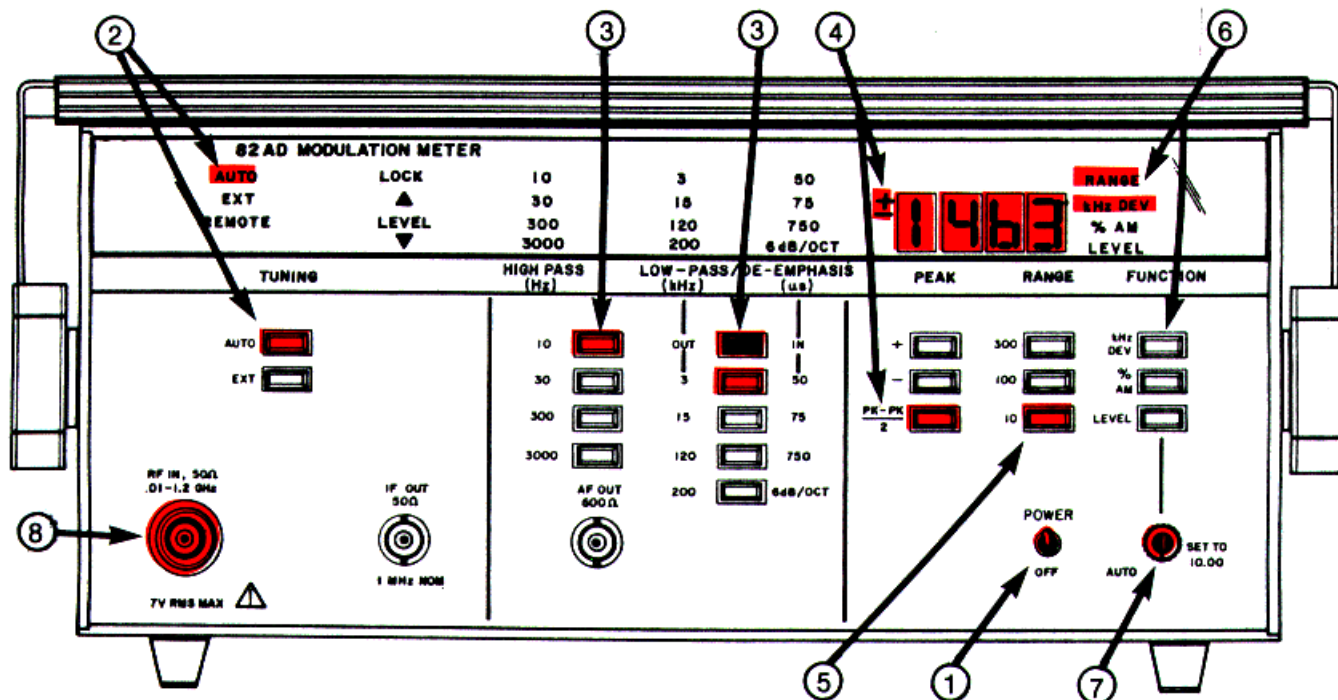

Step (2) Depress the **TUNING AUTO** switch.

Step (3) Select the **HIGH-PASS (Hz)** and **LOW-PASS (kHz)** switches for full scale deviation to be displayed. With **OUT-IN** switch depressed, select the respective **DE-EMPHASIS (us)** filter by depressing **50, 75, 750** or **6 dB/OCT** switch depending upon the characteristics of the FM signal under measurement.

Step (4) Depress the **PEAK +**, **PEAK -**, or **PK-PK** switch depending upon the FM modulation measurement to be made.

Step (5) Depress the **RANGE 300, 100** or **10** switch for full-scale deviation to be displayed.

Step (6) Depress the **FUNCTION kHz DEV** switch.

Step (7) Turn the **AUTO SET TO 10.00** control fully counterclockwise to the **AUTO** position.

Step (8) Connect the rf signal to be measured to the **RF IN** connector.

Step () The **LOCK** annunciator will stop flashing and the **LEVEL** (signal ▼) annunciator will extinguish if the rf level of the input signal is within the correct level range and the frequency of the input signal is within the acceptable frequency range.

Step (10) Read the **kHz DEV** (deviation) from the LED display.

USING EXTERNAL OSCILLATOR (EXT OSC)

- External Local Oscillator (**EXT OSC**)(LO) Measurements

A connector is provided on the rear panel for application of an external local oscillator signal. The external oscillator frequency is determined from the following formula:

$$f_{LO} = (f + 1)/n$$

where f = signal frequency in MHz
 n = any integer which allows f_{LO} to fall between 10 and 20 MHz.

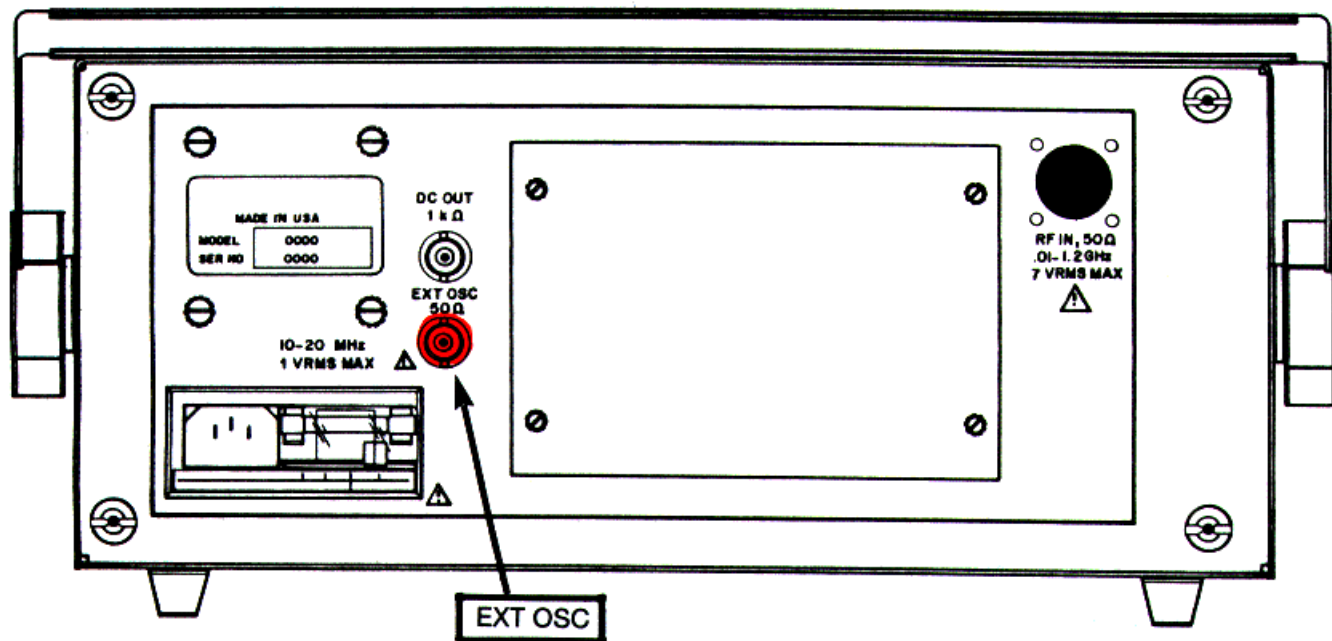

USING EXTERNAL OSCILLATOR (EXT OSC)

Example: For a signal frequency of 100 MHz

- $f_{LO} = (100 + 1)/n = (101)/n$
- For n = 10, $f_{LO} = 10.10$ MHz
- n = 9, $f_{LO} = 11.22$ MHz
- n = 8, $f_{LO} = 12.635$ MHz
- n = 7, $f_{LO} = 14.428$ MHz
- n = 6, $f_{LO} = 16.83$ MHz

Any of the above listed local oscillator frequencies at a level of + 10.0 dBm may be used to produce the proper if.

- The highest possible local oscillator frequency is generally used; however, for applications where a synthesizer type generator is used as the local oscillator signal source, it may be useful to note that a lock point will always exist between 10 and 13 MHz for rf signals above 40 MHz.

Section IV. Operation Under Unusual Conditions

Operation of Modulation Meter ME-525AIUSM in high humidity and in extreme ambient temperature conditions are both considered Unusual Conditions. The ME-525A/USM is normally used in an electronics laboratory or maintenance facility.

- Operation in high humidity conditions affect the dielectrics of electronic components and therefore will result in measurements and indications that will differ from those obtained under lower humidity conditions.
- Operation in extreme temperature conditions will also affect measurement results. Operation in extreme temperature conditions should be avoided when possible.

**CHAPTER 3
OPERATOR MAINTENANCE**

		<i>Page</i>
Section I.	General Operator Maintenance	3-1
Section II.	Troubleshooting Procedures	3-2

Section I. General Operator Maintenance

CLEANING

Use a mild soap or detergent and water. With a clean cloth dampened, not wet, clean the front panel, switches, meter face, cover and rear panel.

ROUTINE CHECKS

- Check control for smooth operation and tightness of knob without binding.
- Check switches for positive action.
- Check connectors for proper seating.
- Check cables for cuts, cracks and other signs of deterioration.

Section II. Troubleshooting Procedures

TROUBLESHOOTING

MALFUNCTION	TEST OR INSPECTION	CORRECTIVE ACTION
1. ALL OF DISPLAY IS BLANK WITH POWER-OFF SWITCH IN POWER POSITION (Power on)	Step 1. Check that primary power is present at ME-525A/USM power input (rear panel).	<ul style="list-style-type: none"> Verify 120 or 240 VAC present at ME-525A/USM.
	Step 2. Check fuse (0.5A, 120 VAC or 0.25A 240 VAC).	<ul style="list-style-type: none"> Verify proper fuse installed.
2. ME-525A/USM DOES NOT OPERATE IN TUNING AUTO MODE.	Step 1. Check connections to signal under test.	<ul style="list-style-type: none"> Verify connections are correct and adequate signal present.
	Step 2. Provide local oscillator signal at rear EXT OSC connector and operate in EXT mode.	<ul style="list-style-type: none"> If operation in TUNING EXT mode is satisfactory, higher level of maintenance needed.
3. ME-525A/USM DOES NOT OPERATE IN TUNING AUTO AND EXT MODE.	Check connections to signal under test.	<ul style="list-style-type: none"> If satisfactory, higher level of maintenance required.



APPENDIX A

REFERENCES

A-1. SCOPE

This appendix lists forms, field manuals, technical manuals and miscellaneous publications referenced in this manual.

A-2. FORMS

DA FORM 2028 Recommended Changes to Publications and Blank Forms.
DA FORM 2028-2 Recommended Changes to Equipment Technical Publications.
SF 368 Quality Deficiency Report.

A-3. FIELD MANUALS

FM 21-11 Artificial Respiration

A-4. TECHNICAL MANUALS

TM 11-6625-3059-24P Organization, Direct Support and General Support Repair Parts and Special Tools Lists for AM/FM Modulation Meter, ME-525A/USM. (NSN 6625-01-161-1459)

A-5. MISCELLANEOUS PUBLICATIONS

DA PAM 310-1 Consolidated Index of Army Publications and Blank Forms.
DA PAM 738-750 The Army Maintenance Management System (TAMMS).

APPENDIX B**COMPONENTS OF END ITEM AND BASIC ISSUE ITEMS LISTS****Section I. Introduction****B-1. SCOPE**

This appendix lists components of end item and basic issue items for the ME-525A/USM to help you inventory items required for safe and efficient operation.

B-2. GENERAL

The Components of End Item and Basic Issue Items Lists are divided into the following sections:

a. Section II. Components of End Item. This listing is for information purposes only, and is not authority to requisition replacements. These items are part of the end item, but are removed and separately packaged for transportation or shipment. As part of the end item, these items must be with the end item whenever it is issued or transferred between property accounts. Illustrations are furnished to assist you in identifying the items.

b. Section III. Basic Issue Items. Not applicable.

B-3. EXPLANATION OF COLUMNS

The following provides an explanation of columns found in the tabular listings:

a. Column (1) - Illustration Number (Illus Number). This column indicates the number of the illustration in which the item is shown.

b. Column (2) - National Stock Number. Indicates the National stock number assigned to the item. The National stock numbers in section III will be used for requisitioning basic issue items.

c. Column (3) - Description. Indicates the National item name and, if required, a minimum description to identify and locate the item. The last line for each item indicates the FSCM (in parentheses) followed by the part number.

d. Column (4) - Unit of Measure (U/M). Indicates the measure used in performing the actual operational/maintenance function. This measure is expressed by a two-character alphabetical abbreviation (e.g., ea, in, pr).

e. Column (5) - Quantity required (Qty Rqd). Indicates the quantity of the item authorized to be used with/on the equipment.

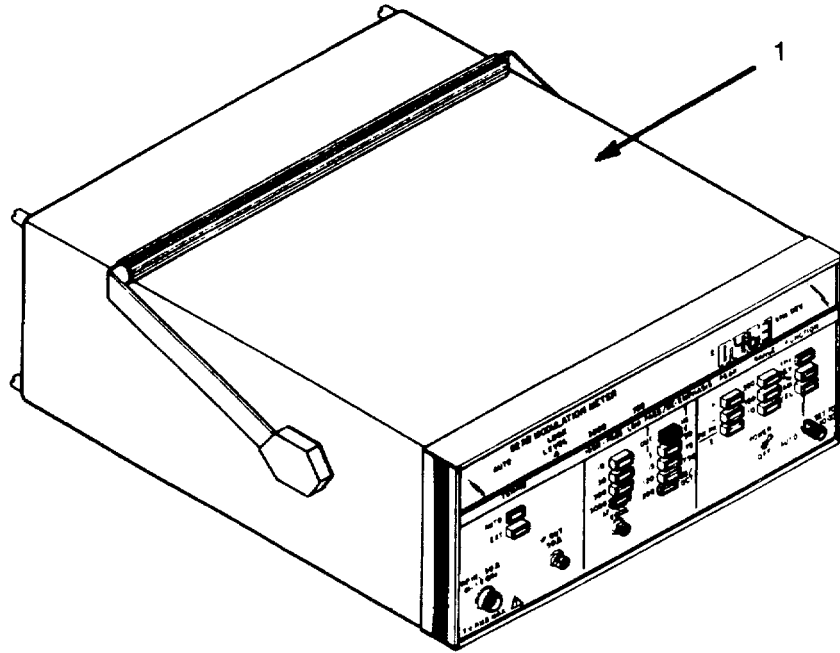

SECTION II COMPONENTS OF END ITEM

(1) ILLUS. NO.	(2) NATIONAL STOCK NUMBER	(3) DESCRIPTION (FSCM) AND PART NUMBER USABLE ON CODE	(4) U.M	(5) QTY REQD
1	6625-01-161-1459	AM/FM Modulation Meter ME-525A/USM	EACH	1

By Order of the Secretary of the Army:

Official:

JOHN A. WICKHAM JR.
General, United States Army
Chief of Staff

DONALD J. DELANDRO
Brigadier General, United States Army
The Adjutant General

DISTRIBUTION:

To be distributed in accordance with DA Form 12-36 literature requirements for ME-525A/USM.

* U.S. GOVERNMENT PRINTING OFFICE: 1993 0 - 342-421 (62013)

The Metric System and Equivalents

Linear Measure

1 centimeter = 10 millimeters = .39 inch
 1 decimeter = 10 centimeters = 3.94 inches
 1 meter = 10 decimeters = 39.37 inches
 1 dekameter = 10 meters = 32.8 feet
 1 hectometer = 10 dekameters = 328.08 feet
 1 kilometer = 10 hectometers = 3,280.8 feet

Weights

1 centigram = 10 milligrams = .15 grain
 1 decigram = 10 centigrams = 1.54 grains
 1 gram = 10 decigrams = .035 ounce
 1 decagram = 10 grams = .35 ounce
 1 hectogram = 10 decagrams = 3.52 ounces
 1 kilogram = 10 hectograms = 2.2 pounds
 1 quintal = 100 kilograms = 220.46 pounds
 1 metric ton = 10 quintals = 1.1 short tons

Liquid Measure

1 centiliter = 10 milliliters = .34 fl. ounce
 1 deciliter = 10 centiliters = 3.38 fl. ounces
 1 liter = 10 deciliters = 33.81 fl. ounces
 1 dekaliter = 10 liters = 2.64 gallons
 1 hectoliter = 10 dekaliters = 26.42 gallons
 1 kiloliter = 10 hectoliters = 264.18 gallons

Square Measure

1 sq. centimeter = 100 sq. millimeters = .155 sq. inch
 1 sq. decimeter = 100 sq. centimeters = 15.5 sq. inches
 1 sq. meter (centare) = 100 sq. decimeters = 10.76 sq. feet
 1 sq. dekameter (are) = 100 sq. meters = 1,076.4 sq. feet
 1 sq. hectometer (hectare) = 100 sq. dekameters = 2.47 acres
 1 sq. kilometer = 100 sq. hectometers = .386 sq. mile

Cubic Measure

1 cu. centimeter = 1000 cu. millimeters = .06 cu. inch
 1 cu. decimeter = 1000 cu. centimeters = 61.02 cu. inches
 1 cu. meter = 1000 cu. decimeters = 35.31 cu. feet

Approximate Conversion Factors

<i>To change</i>	<i>To</i>	<i>Multiply by</i>	<i>To change</i>	<i>To</i>	<i>Multiply by</i>
inches	centimeters	2.540	ounce-inches	Newton-meters	.007062
feet	meters	.305	centimeters	inches	.394
yards	meters	.914	meters	feet	3.280
miles	kilometers	1.609	meters	yards	1.094
square inches	square centimeters	6.451	kilometers	miles	.621
square feet	square meters	.093	square centimeters	square inches	.155
square yards	square meters	.836	square meters	square feet	10.764
square miles	square kilometers	2.590	square meters	square yards	1.196
acres	square hectometers	.405	square kilometers	square miles	.386
cubic feet	cubic meters	.028	square hectometers	acres	2.471
cubic yards	cubic meters	.765	cubic meters	cubic feet	35.315
fluid ounces	milliliters	29.573	cubic meters	cubic yards	1.308
pints	liters	.473	milliliters	fluid ounces	.034
quarts	liters	.946	liters	pints	2.113
gallons	liters	3.785	liters	quarts	1.057
ounces	grams	28.349	liters	gallons	.264
pounds	kilograms	.454	grams	ounces	.035
short tons	metric tons	.907	kilograms	pounds	2.205
pound-feet	Newton-meters	1.356	metric tons	short tons	1.102
pound-inches	Newton-meters	.11296			

Temperature (Exact)

°F	Fahrenheit temperature	5/9 (after subtracting 32)	Celsius temperature	°C
----	------------------------	----------------------------	---------------------	----

PIN: 057909-000